

2.54mm(.100") BOX HEADER IDC TYPE

MATERIAL

Insulator: PBT+GF UL94V-0
 Color: Grey
 Contact: Brass
 Plating: Selective gold plated

SPECIFICATIONS

Temperature range: -55°C ~ +105°C
 Current rating: 1.0A
 Dielectric withstand voltage: 500V AC
 Insulation resistance: 1000 MΩ Min.
 Contact resistance: 0.03 Ω Max.

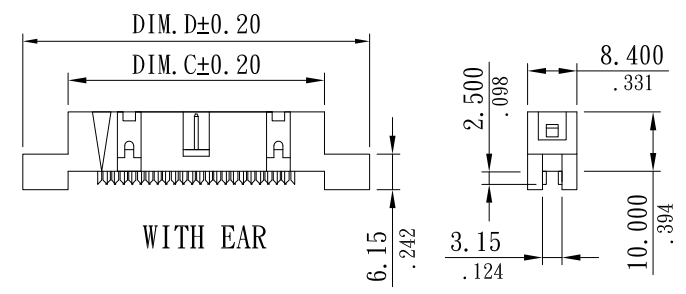
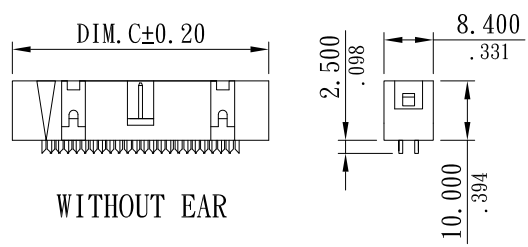
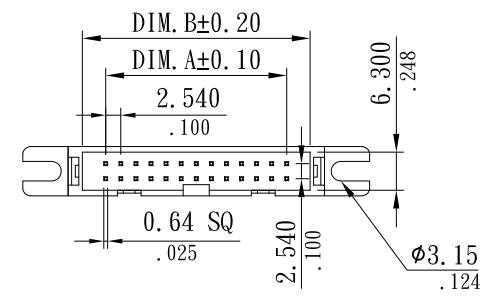
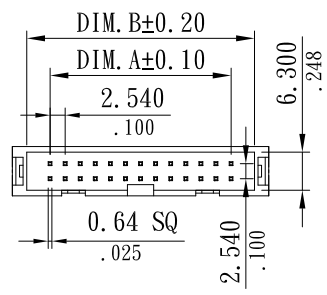

WITHOUT EAR

WITH EAR

Order Information

R 315 x -xxP-x
 1 2 3 4 5

1. RoHS
2. Series
3. Strain relief:
 0=without strain relief
 1=with strain relief
4. Pin No.
5. Mounting ear:
 Y=with ear
 N=without ear

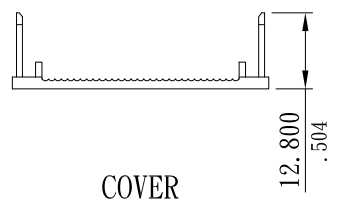

COVER

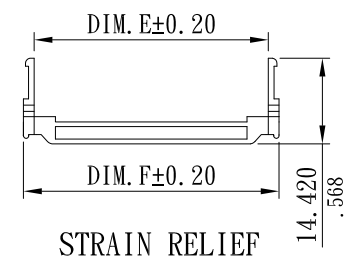

STRAIN RELIEF



Sunny Young Enterprise Co., Ltd. S. Y. E. http://www.sunnyyoung.com.tw 13F., No. 116, Sec. 1, Xintai 5th Rd., Xizhi Dist., New Taipei City 221, Taiwan Tel:+886 2 2696 1668(REP) Fax:+886 2 2696 2668	M008	NAME	DATE	SCALE: NTS	REV NO	DATE	DESCRIPTION	BY	CHECKED	TOLERANCE UNLESS NOTED	
	DRAWN	RALF	2019.05.13	UNIT: mm(in.)	A					LINEAR±	.0 ±0.30(.012)
	CHECKED	EASON	2019.05.13	CAD NO	B						.00 ±0.20(.008)
PART NO	R315x-xxP-x	APPROVED	APPLE	2019.05.13	R315x-xxP-x	C					PROJECTION:

Dimensional Information

Circuits	DIM. A		DIM. B		DIM. C		DIM. D		DIM. E		DIM. F	
	mm	in	mm	in	mm	in	mm	in	mm	in	mm	in
10	10.16	0.400	18.00	0.709	23.00	0.906	37.20	1.465	19.72	0.776	23.00	0.906
14	15.24	0.600	23.08	0.909	28.08	1.106	42.28	1.665	24.80	0.976	28.08	1.106
16	17.78	0.700	25.62	1.009	30.62	1.206	44.82	1.765	27.34	1.076	30.62	1.206
20	22.86	0.900	30.70	1.209	35.70	1.406	49.90	1.965	32.42	1.276	35.70	1.406
24	27.94	1.100	35.78	1.409	40.78	1.606	54.98	2.165	37.50	1.476	40.78	1.606
26	30.48	1.200	38.32	1.509	43.32	1.706	57.52	2.265	40.04	1.576	43.32	1.706
30	35.56	1.400	43.40	1.709	48.40	1.906	62.60	2.465	45.12	1.776	48.40	1.906
34	40.64	1.600	48.48	1.909	53.48	2.106	67.68	2.665	50.20	1.976	53.48	2.106
40	48.26	1.900	56.10	2.209	61.10	2.406	75.30	2.965	57.82	2.276	61.10	2.406
50	60.96	2.400	68.80	2.709	73.80	2.906	88.00	3.465	70.52	2.776	73.80	2.906
60	73.66	2.900	81.50	3.209	86.50	3.406	100.70	3.965	83.22	3.276	86.50	3.406
64	78.74	3.100	86.58	3.409	91.58	3.606	105.78	4.165	88.30	3.476	91.58	3.606



 Sunny Young Enterprise Co., Ltd. S. Y. E. http://www.sunnyyoung.com.tw 13F., No. 116, Sec. 1, Xintai 5th Rd., Xizhi Dist., New Taipei City 221, Taiwan Tel: +886 2 2696 1668(REP) Fax: +886 2 2696 2668	M008	NAME	DATE	SCALE: NTS	REV NO	DATE	DESCRIPTION	BY	CHECKED	TOLERANCE UNLESS NOTED	
	DRAWN	RALF	2019.05.13	UNIT: mm(in.)	A					LINEAR±	.0 ±0.30(.012)
	CHECKED	EASON	2019.05.13	CAD NO	B						.00 ±0.20(.008)
	APPROVED	APPLE	2019.05.13	R315x-xxP-x	C						.000±0.10(.004)
PART NO	R315x-xxP-x		PROJECTION: 