

2.54mm(.100") HOUSING

MATERIAL

Insulator: P.P.0 UL 94V-0
Color: Black

SPECIFICATIONS

Temperature range: -25°C ~ +85°C
Current rating: 3.0A
Voltage rating: 250V AC
Withstanding voltage: 1000V AC
Insulation resistance: 1000 MΩ Min.
Contact resistance: 0.02Ω Max.

Mates with S.Y.E. R2443 Terminal
Mates with S.Y.E. R2441 Wafer(Heraders)

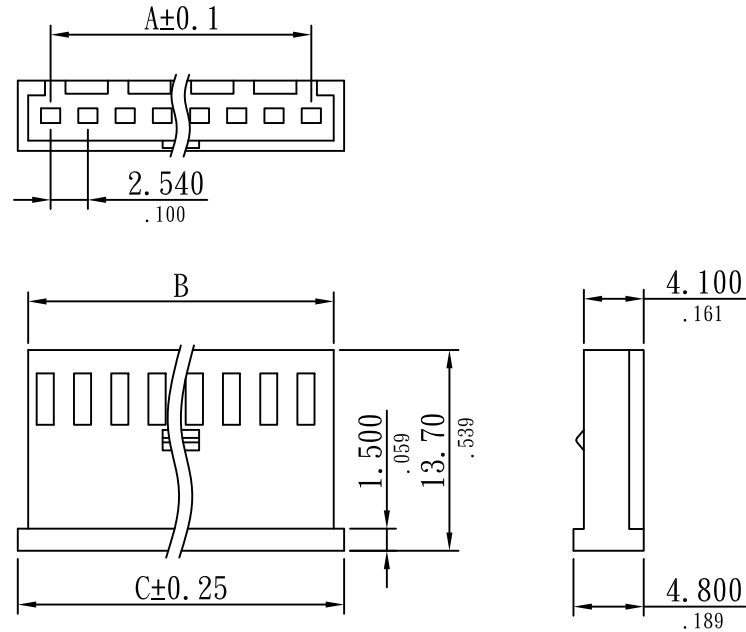

Order Information

R 2440-xxP
1 2 3

1. RoHS
2. Series No.
3. Pin No.

Dimensional Information

Circuits	Dim. A	Dim. B	Dim. C	Circuits	Dim. A	Dim. B	Dim. C
2	2.54(0.100)	5.60(0.220)	7.00(0.276)	13	30.48(1.200)	33.54(1.320)	34.94(1.376)
3	5.08(0.200)	8.14(0.320)	9.54(0.376)	14	33.02(1.300)	36.08(1.420)	37.48(1.476)
4	7.62(0.300)	10.68(0.420)	12.08(0.476)	15	35.56(1.400)	38.62(1.520)	40.02(1.576)
5	10.16(0.400)	13.22(0.520)	14.62(0.576)	16	38.10(1.500)	41.16(1.620)	42.56(1.676)
6	12.70(0.500)	15.76(0.620)	17.16(0.676)	17	40.64(1.600)	43.70(1.720)	45.10(1.776)
7	15.24(0.600)	18.30(0.720)	19.70(0.776)	18	43.18(1.700)	46.24(1.820)	47.64(1.876)
8	17.78(0.700)	20.84(0.820)	22.24(0.876)	19	45.72(1.800)	48.78(1.920)	50.18(1.976)
9	20.32(0.800)	23.38(0.920)	24.78(0.976)	20	48.26(1.900)	51.32(2.020)	52.72(2.076)
10	22.86(0.900)	25.92(1.020)	27.32(1.076)	21	50.80(2.000)	53.86(2.120)	55.26(2.176)
11	25.40(1.000)	28.46(1.120)	29.86(1.176)	22	53.34(2.100)	56.40(2.220)	57.80(2.276)
12	27.94(1.100)	31.00(1.220)	32.40(1.276)				



Sunny Young Enterprise Co., Ltd.

S. Y. E. <http://www.sunnyyoung.com.tw>

13F., No. 116, Sec. 1, Xintai 5th Rd., Xizhi Dist., New Taipei City 221, Taiwan

Tel: +886 2 2696 1668(REP) Fax: +886 2 2696 2668

S034	NAME	DATE	SCALE: NTS	REV NO	DATE	DESCRIPTION	BY	CHECKED	TOLERANCE UNLESS NOTED	
DRAWN	YXF	2009.09.01	UNIT: mm(in.)	A					LINEAR±	.0 ±0.30(.012)
CHECKED	PIQI	2009.09.01	CAD NO	B				.00 ±0.20(.008)		
APPROVED	MARS	2009.09.01	R2440-xxP	C				.000±0.10(.004)		
PART NO										PROJECTION:

R2440-xxP

2.54mm(.100") WAFER 90° TYPE

MATERIAL

Insulator: PBT UL94V-0
 Color: Black
 Contact: Brass 0.64mm(.025") square pin
 Plating: Tin plated

SPECIFICATIONS

Temperature range: -25°C ~ +85°C
 Current rating: 3A
 Dielectric withstand voltage: 800V AC/minute
 Insulation resistance: 1000 MΩ Min.
 Contact resistance: 20mΩ Max.

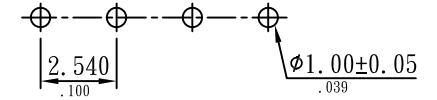
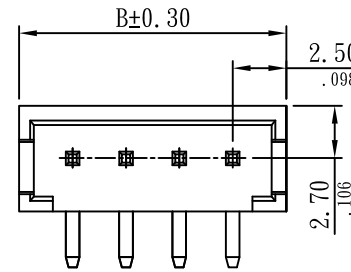

PCB LAYOUT

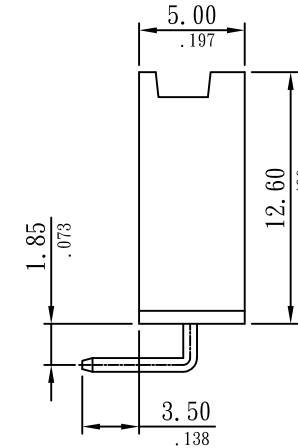
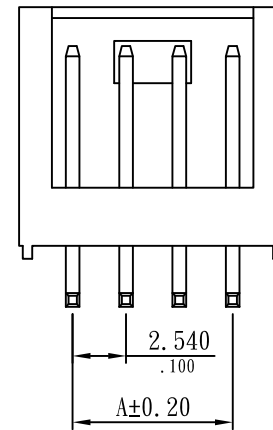

Dimensional Information

Circuits	DIM. A		DIM. B		Circuits	DIM. A		DIM. B	
	mm	in	mm	in		mm	in	mm	in
2	2.54	0.100	7.70	0.303	12	27.94	1.100	33.10	1.303
3	5.08	0.200	10.20	0.402	13	30.48	1.200	35.60	1.402
4	7.62	0.300	12.70	0.500	14	33.02	1.300	38.10	1.500
5	10.16	0.400	15.20	0.598	15	35.56	1.400	40.70	1.602
6	12.70	0.500	17.80	0.701	16	38.10	1.500	43.20	1.701
7	15.24	0.600	20.30	0.799	17	40.64	1.600	45.70	1.799
8	17.78	0.700	22.90	0.902	18	43.18	1.700	48.20	1.898
9	20.32	0.800	25.40	1.000	19	45.72	1.800	50.70	1.996
10	22.86	0.900	28.00	1.102	20	48.26	1.900	53.20	2.094
11	25.40	1.000	30.50	1.201	22	53.34	2.100	58.50	2.303

Order Information

R 2441-xx T R
 1 2 3 4 5

1. RoHS
2. Series
3. Pin No.
4. Tin plated
5. Right angle



Sunny Young Enterprise Co., Ltd.
 S. Y. E. <http://www.sunnyyoung.com.tw>
 13F., No. 116, Sec. 1, Xintai 5th Rd., Xizhi Dist., New Taipei City 221, Taiwan
 Tel:+886 2 2696 1668(REP) Fax:+886 2 2696 2668

S060	NAME	DATE	SCALE: NTS	REV NO	DATE	DESCRIPTION	BY	CHECKED	TOLERANCE UNLESS NOTED	
DRAWN	RALF	2019.05.17	UNIT: mm(in.)	A					LINEAR±	.0 ±0.30(.012)
CHECKED	EASON	2019.05.17	CAD NO	B						.00 ±0.20(.008)
APPROVED	APPLE	2019.05.17	R2441-xxTR	C						.000±0.10(.004)
PART NO	R2441-xxTR								PROJECTION:	

2.54mm(.100") WAFER 180° TYPE

MATERIAL

Insulator: PBT UL94V-0
 Color: Black
 Contact: Brass 0.64mm(.025") square pin
 Plating: Tin plated

SPECIFICATIONS

Temperature range: -25°C ~ +85°C
 Current rating: 3A
 Dielectric withstand voltage: 800V AC/minute
 Insulation resistance: 1000 MΩ Min.
 Contact resistance: 20mΩ Max.

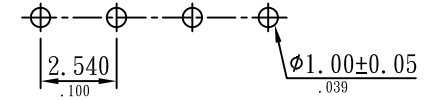
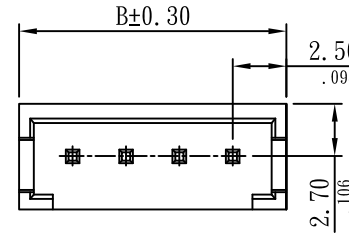

PCB LAYOUT

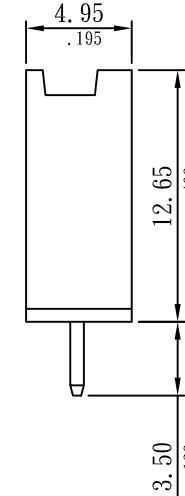
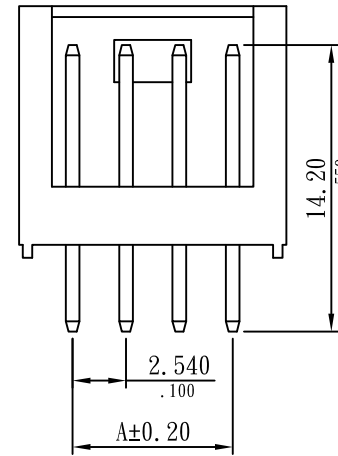

Dimensional Information

Circuits	DIM. A		DIM. B		Circuits	DIM. A		DIM. B	
	mm	in	mm	in		mm	in	mm	in
2	2.54	0.100	7.70	0.303	12	27.94	1.100	33.10	1.303
3	5.08	0.200	10.20	0.402	13	30.48	1.200	35.60	1.402
4	7.62	0.300	12.70	0.500	14	33.02	1.300	38.10	1.500
5	10.16	0.400	15.20	0.598	15	35.56	1.400	40.70	1.602
6	12.70	0.500	17.80	0.701	16	38.10	1.500	43.20	1.701
7	15.24	0.600	20.30	0.799	17	40.64	1.600	45.70	1.799
8	17.78	0.700	22.90	0.902	18	43.18	1.700	48.20	1.898
9	20.32	0.800	25.40	1.000	19	45.72	1.800	50.70	1.996
10	22.86	0.900	28.00	1.102	20	48.26	1.900	53.20	2.094
11	25.40	1.000	30.50	1.201	22	53.34	2.100	58.50	2.303



Order Information

R 2441-xx T S
 1 2 3 4 5

1. RoHS
2. Series
3. Pin No.
4. Tin plated
5. Straight angle

Sunny Young Enterprise Co., Ltd.
 S. Y. E. <http://www.sunnyyoung.com.tw>
 13F., No. 116, Sec. 1, Xintai 5th Rd., Xizhi Dist., New Taipei City 221, Taiwan
 Tel:+886 2 2696 1668(REP) Fax:+886 2 2696 2668

S060	NAME	DATE	SCALE: NTS	REV NO	DATE	DESCRIPTION	BY	CHECKED	TOLERANCE UNLESS NOTED	
DRAWN	RALF	2019.05.17	UNIT: mm(in.)	A					LINEAR±	.0 ±0.30(.012)
CHECKED	EASON	2019.05.17	CAD NO	B						.00 ±0.20(.008)
APPROVED	APPLE	2019.05.17	R2441-xxTS	C						.000±0.10(.004)
PART NO	R2441-xxTS								PROJECTION:	

2.54mm(.100") TERMINAL

SPECIFICATIONS

Material : Phosphor bronze
 Plating : Tin plated
 Applicable wire : AWG 26 ~ AWG 22
 Insulation O.D. : 1.55mm Max.
 Used in S.Y.E. R2440 Housing

Order Information

R 2443-F-P T-1
 1 2 3 4 5

1. RoHS
2. Series No.
3. Female
4. Phosphor bronze
5. Tin plated

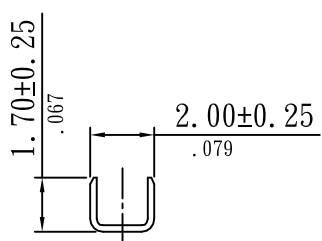

SECTION A-A

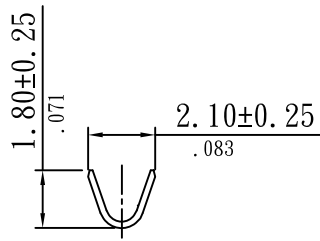

SECTION B-B

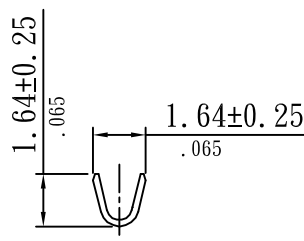

SECTION C-C

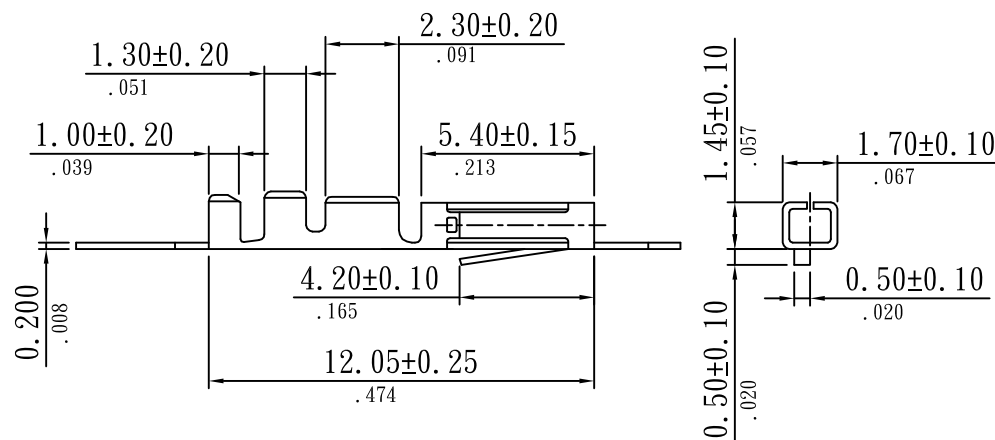

SECTION D-D

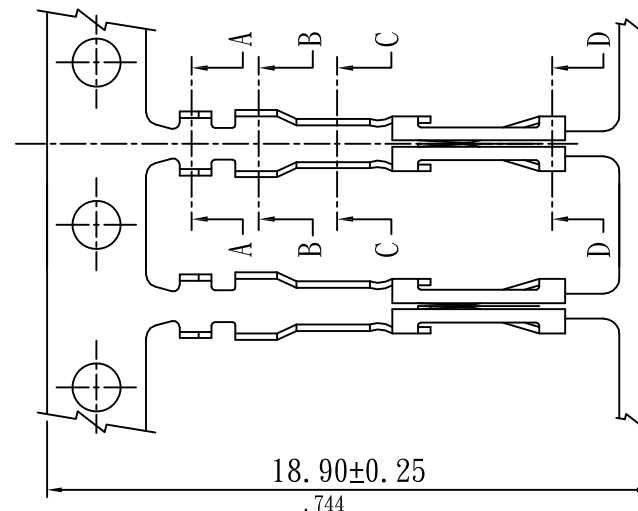

S.Y.E. Sunny Young Enterprise Co., Ltd.
 S. Y. E. <http://www.sunnyyoung.com.tw>
 13F., No.116, Sec.1, Xintai 5th Rd., Xizhi Dist., New Taipei City 221, Taiwan
 Tel:+886 2 2696 1668(REP) Fax:+886 2 2696 2668

S008	NAME	DATE	SCALE: NTS	REV NO	DATE	DESCRIPTION	BY	CHECKED	TOLERANCE UNLESS NOTED	
DRAWN	RALF	2020.12.02	UNIT: mm(in.)	A					LINEAR±	.0 ±0.25(.010)
CHECKED	DEAN	2020.12.03	CAD NO	B						.00 ±0.15(.006)
APPROVED	APPLE	2020.12.03	R2443-F-PT-1	C						.000±0.05(.002)
									PROJECTION:	

PART NO R2443-F-PT-1